



Bosch

Installation Guidelines for Cabin Filters

Part Number: AP-T02
0986 AF7 003

This manual describes how to replace the cabin filter. Before installing, please be sure to read this book to ensure safe and correct installation.

Estimated Installation Time: 5-10 minutes

In some cases, tools are required and replacement work adds additional time.

Recommended replacement time

1 year or 10,000km

However, it is recommended to check and replace your cabin filter as soon as possible when driving in heavily soiled areas.

The contents of this installation guide are accurate as of May 2022

Precautions for installation and use

- Be sure to park your vehicle in a safe place with the engine and air conditioner turned off before commencing the replacement process.
- When replacing your cabin filter, please refer to the instruction manual of the vehicle, maintenance manual, etc.
- This guide is just an example and may differ from the actual vehicle.
- Please refrain from unreasonable work. It may result in damaging the vehicle or personal injury.
- If you are not confident in the work please consult your local workshop.
- Check the direction of the arrow so that you do not mistake the front and back of the filter when installing.
- This product displays AIR FLOW (wind direction) with an arrow, but other companies may display "TOP UP" on their filters.

Robert Bosch (Australia) Pty. Ltd.
1555 Centre Road
Clayton VIC 3168

For Further information please contact Bosch on:
Email: CustomerService.AA@au.bosch.com
Australia: **1300 307 040** www.boschaftermarket.com.au
New Zealand **0800 452 896** www.boschaftermarket.co.nz

T02 Cabin Filter Installation Guide

1. How to remove the glove box

Step 1 Other Vehicles

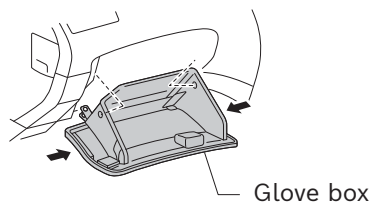

Open the glove box and press from both sides to remove the stoppers (2 places). Press inwards to remove the glove box.

For Celica

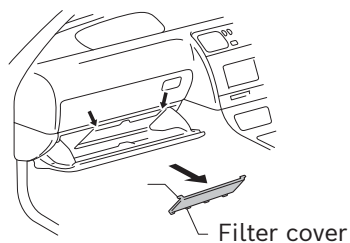

Open the glove box and remove the cover located at the back of the glove box. Do not remove glove box.

For Prius

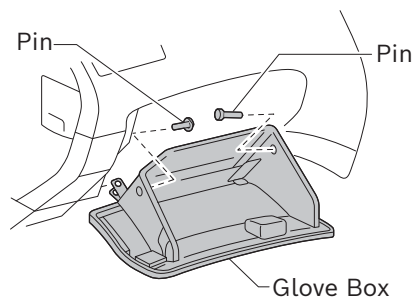

For Voxy, Noah, and Estima

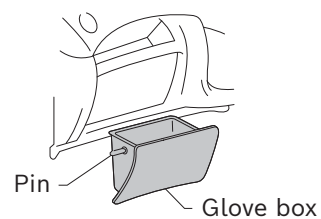

Open the glove box and press down both pins to remove the pins (2 places). Press inwards to remove the glove box.

For Camry and Alphard

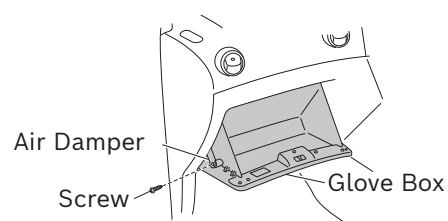

Open the glove box and remove the air damper and screw. Press inwards to remove the

Open the glove box, remove the inner pins (2 places). Press inwards to remove the glove box.

2. Removing the cabin filter

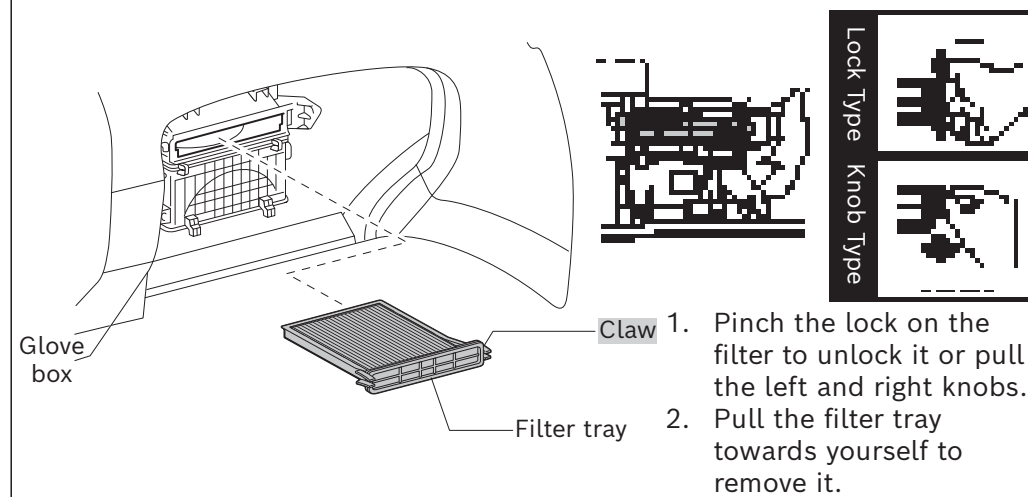

1. Pinch the lock on the filter to unlock it or pull the left and right knobs.
2. Pull the filter tray towards yourself to remove it.

3. How to install your Bosch cabin filter

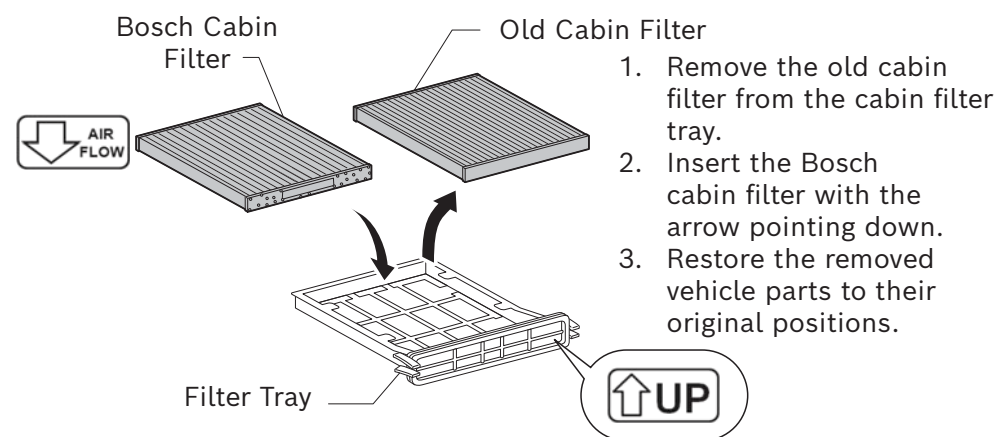

1. Remove the old cabin filter from the cabin filter tray.
2. Insert the Bosch cabin filter with the arrow pointing down.
3. Restore the removed vehicle parts to their original positions.

⚠ Attention

- This work procedure is an example and may vary across different vehicles.
- Bosch's cabin filter indicates airflow with an arrow on the product. Please note that the arrow may indicate "TOP" on other genuine or IAM products.
- Please read the "Precautions for installation and use" on the installation guide cover before commencing.
- NOTE: used cabin filters cannot be cleaned and reused.